

PRODUCT CODE: PW12
PENNY WASHER

DESCRIPTION

M12 Penny Washer: 25mm Outer Diameter

FINISH

BZP

MATERIAL

Steel

PACKAGING

Packed in qty 100

ADDITIONAL NOTES

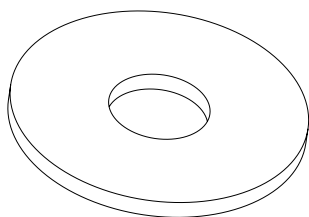

Isometric view

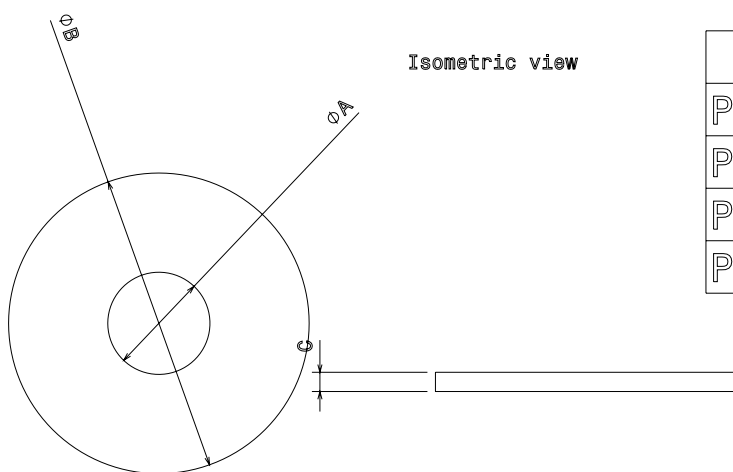

Top view

Side view

	A	B	C
PW6	M6	25	1.6
PW8	M8	25	1.6
PW10	M10	25	1.6
PW12	M12	25	1.6